

专利产品

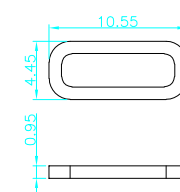
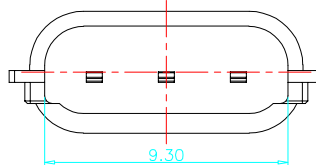
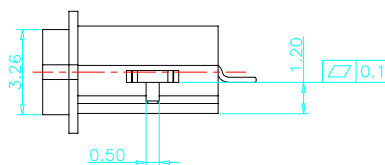
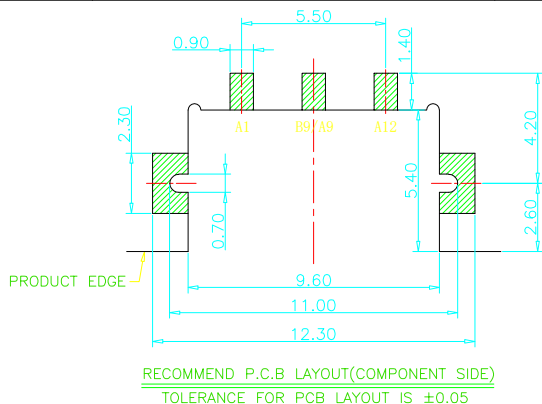
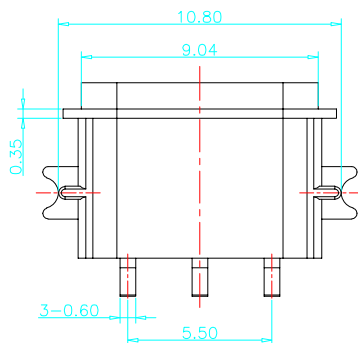
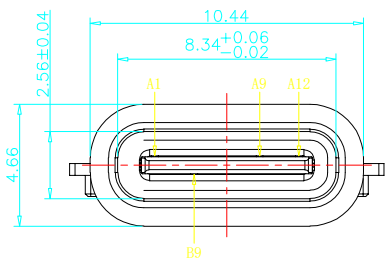
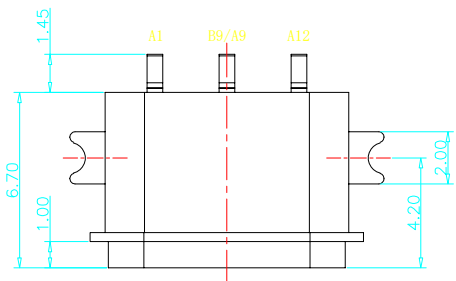

防水圈图

NOTES:

SPECIFICATION:

- 1.CURRENT RATING: 3.0 A
- 2.VOLTAGE RATING: 3.0 V
- 3.VBUS & GND PINS AND OTHER PINS: 40mΩ/PIN MAX
SHIELD: 50mΩ/MAX
LLCR MAX. CHANGE OF ALL PINS: 100m
- 4.INSULATION RESISTANCE: 100MΩ MIN
- 5.DIELECTRIC WITHSTAND VOLTAGE, AC 100V FOR 1MINUTE
- 6.INSERTION FORCE: 0.5-2.0kgf
- 7.UNMATING FORCE: 0.8-2.0kgf
- 8.DURABILITY: 10000 CYCLES
- 9.OPERATING TEMPERATURE: -35°C~+85°C
- 10.THE PEAK TEMPERATURE ON THE BOARD SHALL BE MAINTAINED FOR 10 SECONDS AT 210-230°C
- 11.WATERPROOF: IP-X7.

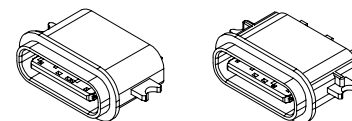

USB TYPE C PIN ASSIGNMENTS

PIN NUMBER	SIGNAL NAME
A1	GND
A9/B9	VBUS
A12	GND

TABLE:

NO	PART	Q'TY	Material
1	SHELL	1	ZINC ALLOY, NI PLATED
2	CONTACT	3	COPPER STEEL, TIN/Au/NI PLATED
3	MID PLATE	1	STAINLESS STEEL, NO PLATING
4	1MD HOUSING	1	HIGH TEMPERATURE RESISTANT PLASTIC BLACK UL94 V-0
5	WATERPROOF RING	1	SILICONE UL94 V-0 BLACK

东莞市溪榜电子有限公司
DONG GUAN XI BANG ELECTRONICS CO., LTD.

品名 (ITEM NO)	TYPE C 3P 沉板1.2防水母座L=6.7mm(带钢片)(外壳锌合金)
料号 (PART NO)	
图号 (DWG NO)	

页码 (SHEET)	1/1	单位 (UNIT):	MM
版本 (REV)	A0	比例 (SCALE):	1:1
日期 (DATE)	2022. 04. 13	设计 (DESIGN)	Lee
设计 (DESIGN)	Lee	审核 (CHECKED)	LSW
审核 (CHECKED)	LSW	核准 (APPROVED)	CJL
核准 (APPROVED)	CJL	未注公差 (TOLERANCE UNSPECIFIED)	X.X ±0.20 X.XX ±0.15 X.XXX ±0.10 X° ±5° X.X° ±2°

These drawings and specifications are the property of Dongguan Xibang Electronics Co., Ltd. and should not be copied. Without the prior written consent of Dongguan Xibang Electronics Co., Ltd., it shall not be copied or used in any way.